

Rosemount 2120 Vibrating Fork Liquid Level Switch



DIBt CE Ex

2120 Vibrating Fork Liquid Level Switch

IMPORTANT NOTICE

Read this manual before working with the product. For personal and system safety, and for optimum product performance, make sure you thoroughly understand the contents before installing, using, or maintaining this product.

The United States has two toll-free assistance numbers and one International number.

Customer Central

1-800-999-9307 (7:00 a.m. to 7:00 P.M. CST)

International

1-(952) 906-8888

National Response Center

1-800-654-7768 (24 hours a day)

Equipment service needs

CAUTION

The products described in this document are NOT designed for nuclear-qualified applications. Using non-nuclear qualified products in applications that require nuclear-qualified hardware or products may cause inaccurate readings.

For information on Emerson Process Management nuclear-qualified products, contact your local Emerson Process Management Sales Representative.

CAUTION

Rosemount pursues a policy of continuous development and product improvement. The specification in this document may therefore be changed without notice. To the best of our knowledge, the information contained in this document is accurate and Rosemount cannot be held responsible for any errors, omissions or other misinformation contained herein. No part of this document may be photocopied or reproduced without the prior written consent of Rosemount.



Table of Contents

SECTION 1

Introduction

Switch Overview	1-2
Short Fork Technology	1-2
Rosemount 2120 Application and Mounting Examples	1-2
Overfill Protection	1-3
Limit Detection	1-3
Pipe Installation (Pump Protection)	1-3
High and Low Level Alarm	1-3
Hygienic Applications	1-3
Application Considerations:	1-4
Handling the 2120	1-4
Device Identification	1-5
Installation Considerations and Recommendations	1-6
Switchpoint	1-8
Service Support	1-8
Warranty	1-8

SECTION 2

Installation

Safety Messages	2-1
Mechanical Installation	2-2
Correct Fork Alignment	2-2
Pipe Installation	2-3
Vessel Installation	2-3
Cable Gland Orientation	2-4
Set Mode Switch / Switching Time Delay	2-4
LED Indication	2-6
Electrical Installation	2-7
2120 Direct Load Switching	2-7
2120 PNP/PLC Version	2-9
2120 Relay Output	2-11
2120 Intrinsically Safe NAMUR	2-13



Rosemount 2120

SECTION 3**Service & Troubleshooting**

Magnetic Test Point	3-1
Inspection	3-2
2120 Maintenance	3-2
Troubleshooting	3-3
Spare Parts	3-3
Replacement and Calibration of Electronic (PCB) Cassettes	3-4
Replacement Sequence	3-4
To replace the cassette, do the following:	3-5
Calibration Sequence	3-6

APPENDIX A**Reference Data**

Specifications	A-1
Physical	A-1
Mechanical	A-1
Performance	A-2
Functional	A-2
Electrical	A-4
Dimensional Drawings	A-5
Threaded Mounting	A-5
Flange Mounting	A-6
Hygienic Fitting	A-7
Ordering Information	A-8
Spare Parts and Accessories	A-11

APPENDIX B

Product Certifications

Ordinary Location Certification for FM. B-1

European Directive Information. B-1

 ATEX Directive (94/9/EC). B-1

 Pressure Equipment Directive (PED) (97/23/EC). B-1

 L.V. Directive B-1

 Electro Magnetic Compatibility (EMC) Directive. B-1

 Vibration Resistance B-1

 CE-mark B-1

Overfill protection B-1

Approved Manufacturing Locations. B-1

Hazardous Locations Certifications. B-2

North American Approvals B-2

 Factory Mutual (FM) Explosion Proof Approval B-2

 Instructions specific to hazardous area installations B-2

 Factory Mutual (FM) Intrinsically Safe Approval B-4

 Instructions specific to hazardous (classified locations) area installations. B-4

European Approvals B-7

 ATEX Flame Proof Approvals. B-7

 Instructions specific to hazardous area installations B-7

 (Reference European ATEX Directive 94/9/EC, Annex II, 1.0.6.) B-7

 ATEX Intrinsically Safe Approval B-9

 Instructions specific to hazardous area installations B-9

SECTION 1 INTRODUCTION

Switch Overview	page 1-2
Rosemount 2120 Application and Mounting Examples	page 1-2
Handling the 2120	page 1-4
Device Identification	page 1-5
Installation Considerations and Recommendations	page 1-6
Service Support	page 1-8

Procedures and instructions in this manual may require special precautions to ensure the safety of the personnel performing the operations. Information that raises potential safety issues is indicated by a caution symbol (⚠). The external hot surface symbol (🔥) is used when a surface is hot and care must be taken to avoid possible burns. If there is a risk of an electrical shock the (⚡) symbol is used. Refer to the safety messages listed at the beginning of each section before performing an operation preceded by this symbol.

⚠ CAUTION

Failure to follow these installation guidelines could result in death or serious injury.

- Protection afforded by compliance to EN61010-1 (2001) may be impaired if the equipment is not used as specified.
- The Rosemount 2120 is a liquid level switch. It must be installed, connected, commissioned, operated and maintained by suitably qualified personnel only, observing any national and local requirements that may apply.
- Ensure the wiring is suitable for the electrical current and the insulation is suitable for the voltage, temperature and environment.

🔥 External Surface may be hot.

- Care must be taken to avoid possible burns.

Process leaks could result in death or serious injury.

- Do not remove the level switch while in operation. Removing while in operation may cause process fluid leaks.

⚡ Electrical shock could cause death or serious injury.

- If the level switch is installed in a high voltage environment and a fault condition or installation error occurs, high voltage may be present on switch leads and terminals.
- Use extreme caution when making contact with the leads and terminals.



Rosemount 2120

CAUTION

Any substitution of non-recognized parts may jeopardize safety and is under no circumstances allowed.

Switch Overview

The Rosemount 2120 is a liquid point level switch based on the vibrating short fork technology making it suitable for virtually all liquid applications. Complete range of process connections, wide choice of housing and wetted parts materials, four different switching functions, extended fork lengths, hazardous area and overfill approvals makes it configurable to almost all requirements.

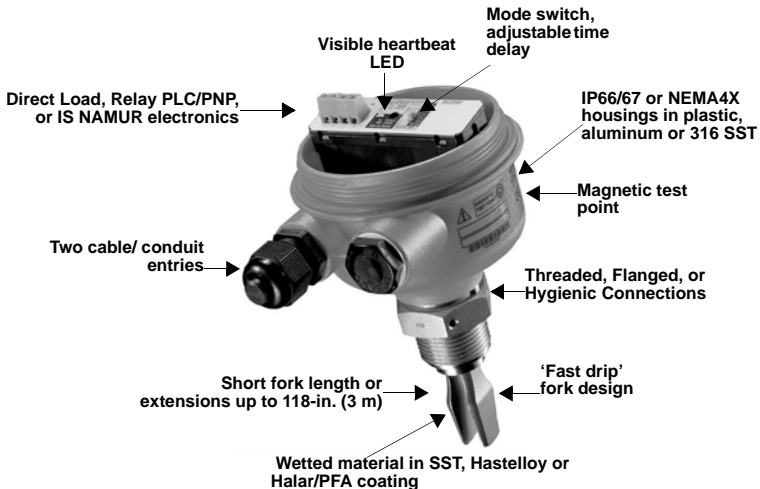

21210/2120 top off.tif

Short Fork Technology

The natural frequency (~1300Hz) of the fork is chosen to avoid interference from plant vibration which may cause false switching. This also gives short fork length for minimal intrusion into vessel and pipe. Using Short Fork Technology, the Rosemount 2120 is designed for use in virtually all liquid applications. Extensive research has maximized the operational effectiveness of the fork design making it suitable for almost all liquids, including coating liquids (avoid bridging of forks), aerated liquids, and slurries.

Rosemount 2120 Application and Mounting Examples

For most liquids including coating and aerated liquids and slurries, the function is virtually unaffected by flow, turbulence, bubbles, foam, vibration, solid particles, build-up (avoid bridging of forks) or properties of the liquid. For use in Hazardous (IS or EExd) or safe area and process temperatures up to 302°F (150°C).

Mount in any position in the tank or pipe. Mounting is by a wide range of threaded, flanged, or hygienic connection.



Overfill Protection

Spillage caused by overfilling can be hazardous to people and the environment, resulting in lost product, and clean up costs. The 2120 is a limit level switch with a built-in visible 'heartbeat LED' used to signal overfill at any time.



Limit Detection

Often batch processing tanks contain stirrers/agitators to ensure mixing and product 'fluidity'. The standard user selectable time delay ranging from 0.3 to 30 seconds virtually eliminates the risk of false switching due to splashing caused by stirrers/agitators.



Pipe Installation (Pump Protection)

Short forks mean minimum intrusion wetside and allow simple low cost installation at any angle into your pipes or vessels. With the fork projecting only 2-in. (50 mm) (dependant on connection type), the 2120 can be installed in even small diameter pipes. By selecting the option of direct load switching electronics, the 2120 is ideal for reliable pump control and can be used to protect against pumps running dry.

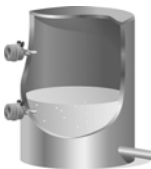

High and Low Level Alarm

Maximum and minimum level detection in tanks containing many different types of liquids are an ideal application for the 2120. The robust 2120 operates continuously at temperatures up to 302°F (150°C) and operating pressure up to 1450 psig (100 barg) making it perfect for use as a high or low level alarm.



Hygienic Applications

With the option of highly polished forks providing a surface finish (Ra) better than 0.8µm, the 2120 meets the principle design criteria of the most stringent hygienic requirements used in food and beverage, and pharmaceutical applications. Manufactured in stainless steel the 2120 is robust enough to easily withstand steam cleaning (CIP) routines at temperatures up to 302°F (150°C).

Rosemount 2120

Application Considerations:

- Ensure liquid is inside the temperature and pressure ranges (see specifications).
- Check that the liquid is inside recommended viscosity range 0.2 to 10,000 cP.
 - Examples of products with too high of viscosity are chocolate syrup, ketchup, peanut butter and bitumen. The switch will still detect these products but the drain time can be very long.
- Check that the liquid density is above 37.5 lb/ft³ (600 kg/m³).
- Examples of products with too low of density are acetone, pentane and hexane.
- Check for risk of build-up on the forks.
 - Avoid situations where drying and coating products may create excessive build-up.
 - Ensure no risk of bridging the forks.
 - If coating, bridging may occur ensure the Halar/PFA coated version is used to reduce the risk of build-up.
- Examples of products that can create bridging of forks are dense paper slurries and bitumen.
- Check the solids content in the liquid.
 - Problems may occur if product coats and dries causing caking.
 - As a guideline maximum solid particle diameter in the liquid is 0.2-in. (5 mm).
 - Extra consideration is needed when dealing with particles bigger than 0.2-in. (5 mm), consult factory.
- Foam
 - In almost all cases the 2120 is insensitive to foams (do not see the foam).
 - However in rare occasions some very dense foams may be seen as liquid, known example of this is found in ice-cream and orange juice manufacturing.

Handling the 2120

Figure 1-1. Do not hold the 2120 by forks.

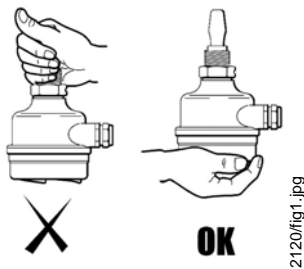
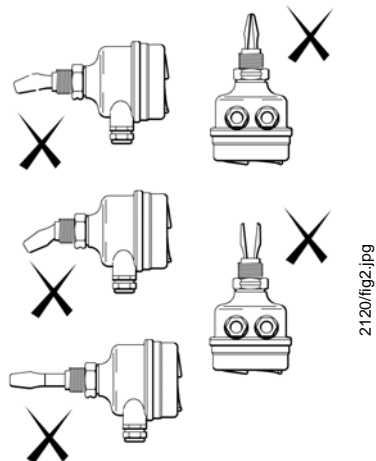
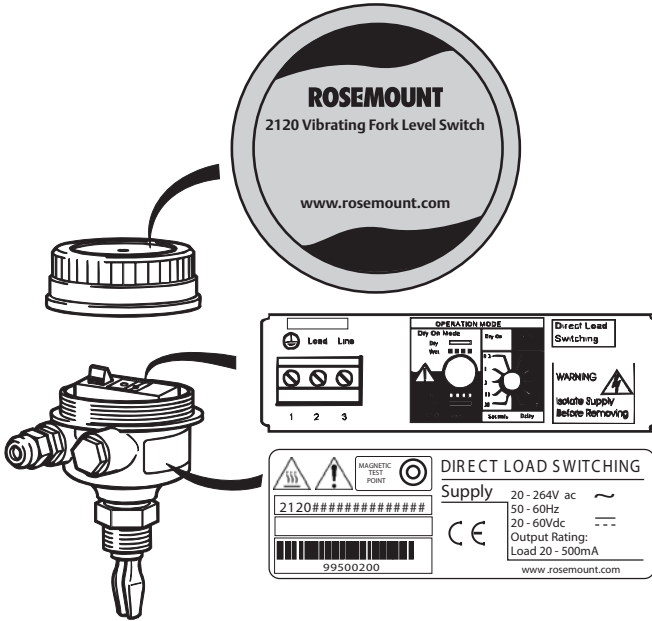

Figure 1-2. Do not alter the 2120 forks in any way.



Device Identification

See Appendix B: Product Certifications for specific product approvals.



2120/2120_24aa.eps

Rosemount 2120

Installation Considerations and Recommendations

Before you install the Rosemount 2120 Level Switch, consider specific installation recommendations and mounting requirements.

- Install in any orientation in tank containing liquid.
- Always install in the normally "on" state. (See "Electrical Installation" on page 2-7)
 - For high level the recommendation is Dry = on.
 - For low level the recommendation is Wet = on.
- Always ensure the system is tested by using the local magnetic test point during commissioning. (See "Magnetic Test Point" on page 3-1)
- Ensure sufficient room for mounting and electrical connection (See "Dimensional Drawings" on page A-5 for switch dimensions.)

Figure 1-3. Ensure Adequate Space Outside Tank

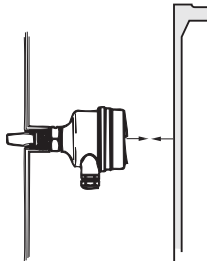

2120/2120_28aa.eps

- Ensure that the forks do not come into contact with the tank wall or any internal fittings or obstructions.
- Avoid installing the 2110 where it will be exposed to liquid entering the tank at the fill point.
- Avoid heavy splashing on the forks.
 - Raising the time delay reduces accidental switching caused by splashing.
- Avoid product buildup.
 - Ensure no risk of bridging the forks.
 - Ensure there is sufficient distance between build-up on the tank wall and the fork.
 - Ensure installation do not create tank crevices around the forks where liquid may collect (important high viscosity and high density liquids).

Figure 1-4. Example of ok and not ok build-up on tank wall.

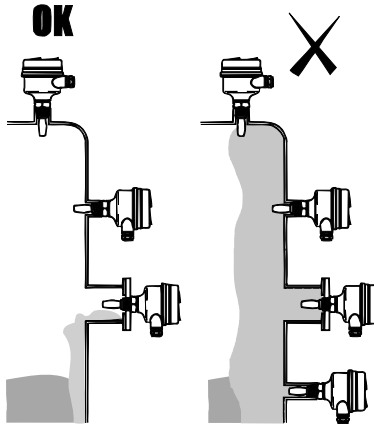

2120/fig9.eps

- Extra consideration is needed if the plant vibration is close to the 1300 Hz operating frequency of the 2110
- Avoid Long Fork Length and Vibration without Supporting the Fork

Figure 1-5. Support fork if high dynamic loads.

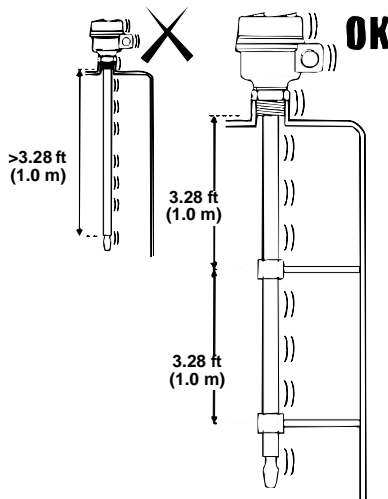

2120/2120_29aaa.eps

Rosemount 2120

Switchpoint

In the top diagram a lower density media will give switchpoint closer to the connection. A higher density media will give switchpoint closer to fork tip.

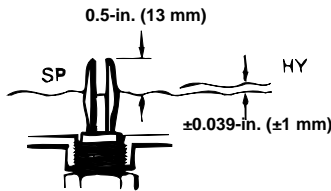
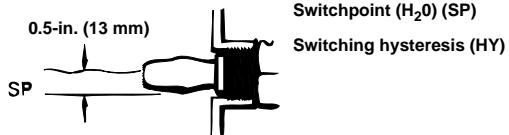
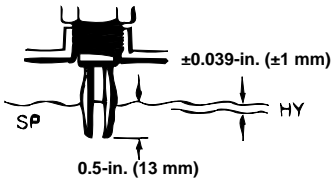

2120/fig12.eps

Service Support

To expedite the return process outside of the United States, contact the nearest Rosemount representative.

Within the United States, call the Rosemount National Response Center using the 1-800-654-RSMT (7768) toll-free number. This center, available 24 hours a day, will assist you with any needed information or materials.

The center will ask for product model and serial numbers, and will provide a Return Material Authorization (RMA) number. The center will also ask for the process material to which the product was last exposed.

Rosemount National Response Center representatives will explain the additional information and procedures necessary to return goods exposed to hazardous substance can avoid injury if they are informed of and understand the hazard. If the product being returned was exposed to a hazardous substance as defined by OSHA, a copy of the required Material Safety Data Sheet (MSDS) for each hazardous substance identified must be included with the returned goods.

Warranty

Emerson Process Management will replace a faulty or failed 2120 with a new unit provided that the fault or failure is reported either directly or via an accredited representative, within 1 year from the date of supply, and the product has been installed and used in accordance with Emerson Process Management instruction manual 00809-0100-4030. Emerson Process Management reserves the right to examine such product and to refuse replacement at its discretion if the above conditions are not met.

SECTION 2 INSTALLATION

Safety Messages	page 2-1
Mechanical Installation	page 2-2
Correct Fork Alignment	page 2-2
Cable Gland Orientation	page 2-4
Set Mode Switch / Switching Time Delay	page 2-4
LED Indication	page 2-6
Electrical Installation	page 2-7

Safety Messages

Procedures and instructions in this manual may require special precautions to ensure the safety of the personnel performing the operations. Information that raises potential safety issues is indicated by a caution symbol (⚠). The external hot surface symbol (🔥) is used when a surface is hot and care must be taken to avoid possible burns. If there is a risk of an electrical shock the (⚡) symbol is used. Refer to the safety messages listed at the beginning of each section before performing an operation preceded by this symbol.



Mechanical Installation

Figure 2-1. Sealing

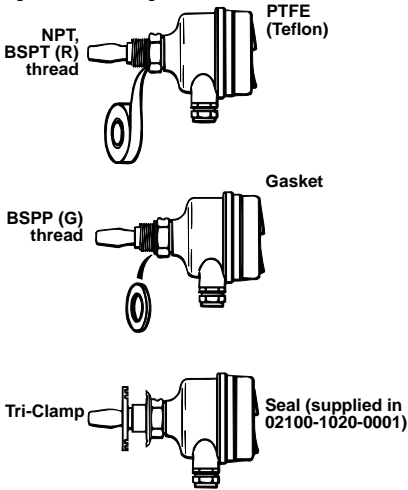
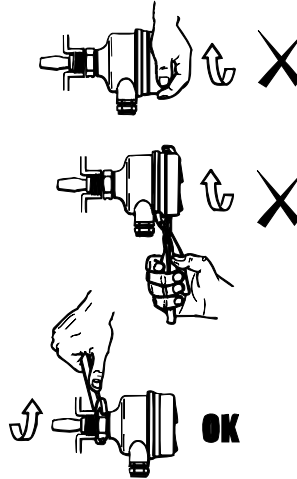

Figure 2-2. Tighten the Switch



2120/fig3, fig4.eps

Correct Fork Alignment

Ensure correct fork alignment.

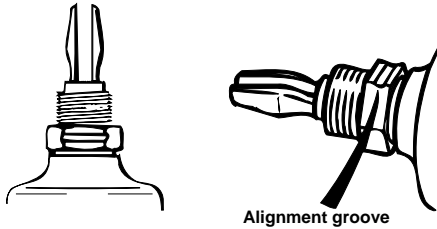

2120/fig6.eps

Pipe Installation

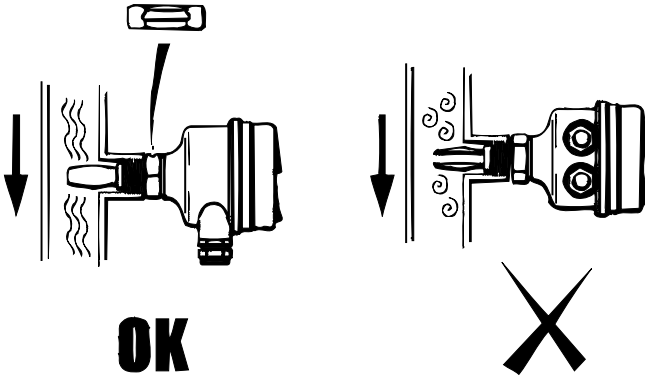

2120/fig7.eps

Vessel Installation

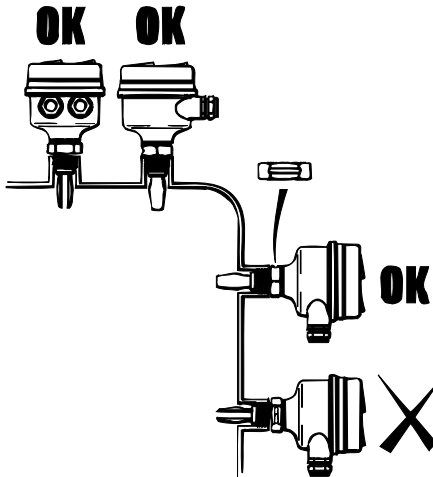

2120/fig8.eps

Cable Gland Orientation

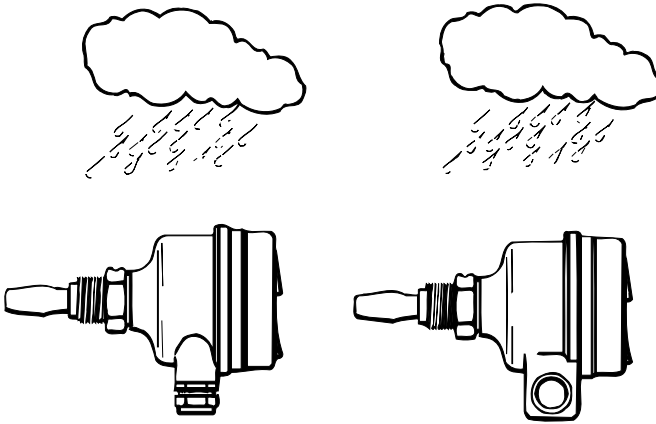

2120/fig10.eps

Set Mode Switch / Switching Time Delay

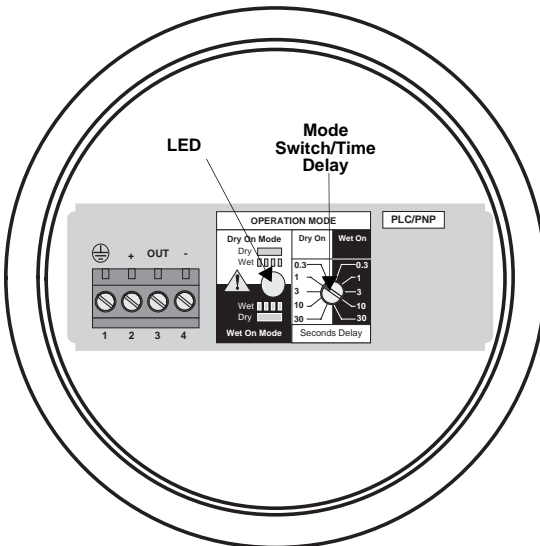

2120/fig11.eps

1. Mode switch

Dry on or wet on mode selection.

2. Switching time delay

0.3, 1, 3, 10, or 30 seconds time delay selection.

Figure 2-3. Mode Dry On, 1 second time delay (typical for high level applications)

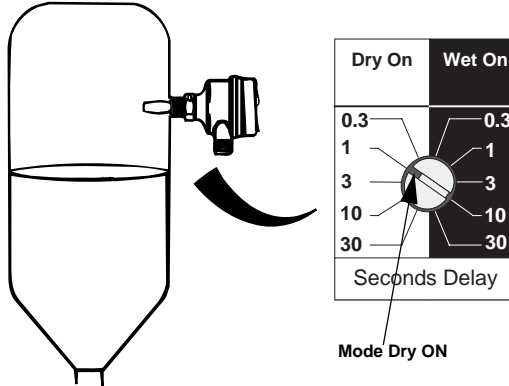

2120/fig11a, fig13b.eps

Figure 2-4. Mode Wet On, 1 second time delay (typical for low level applications)

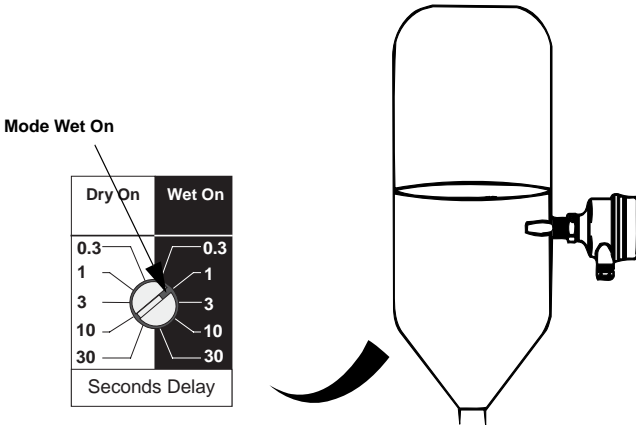







2120/fig11b, fig13c.eps



NOTE:

- There is a five second delay when switching between modes and time delays.
- The small cut-out in the rotating switch indicates the delay/mode chosen.
- Recommended installation for high level is dry on and low level is wet on. Do not install in the normally 'off' state.

LED Indication

	LED Flash Rate	Switch Status
	Continuous	Output state is on
	1 every second	Output state is off
	1 every 2 seconds	Uncalibrated
	1 every 4 seconds	Load fault; load current too high; load short circuit
	2 times / second	Indication of successful calibration
	3 times / second	Internal fault (micro, ROM, or RAM)
	Off	Problem (e.g. supply)

Electrical Installation

-  Isolate supply before connecting the switch or removing the electronics.
-  The functional earth terminal must be connected to an external earthing system.

2120 Direct Load Switching

- Direct load switching (2-wire, Red label)

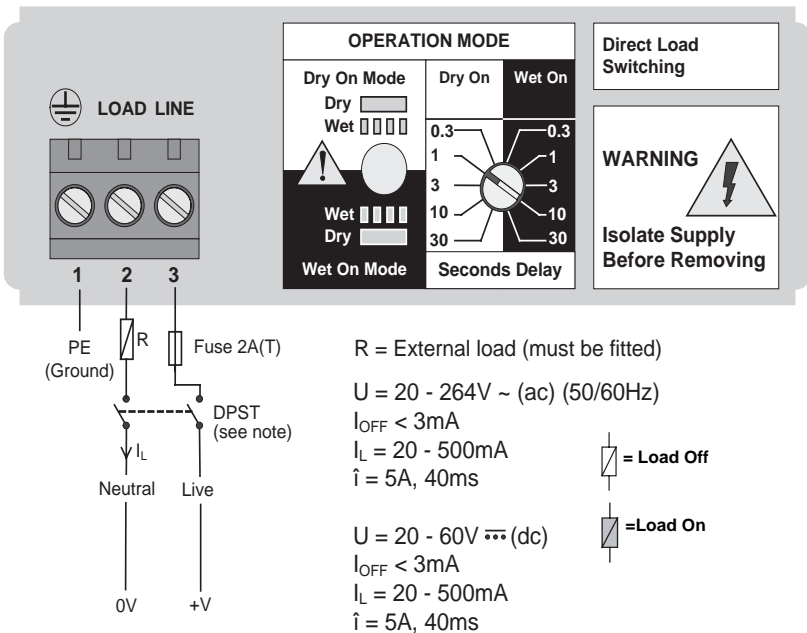

NOTE:

DPST = 'Double Pole, Single Throw' (on/off) switch - must be fitted for safe disconnection of the power supply. Fit the switch as near to the 2120 as possible. Keep the switch free of obstructions. Label the switch to indicate that it is the supply disconnection device for the 2120.

RELAY CONNECTION WARNING:

The Rosemount 2120 requires a minimum current of 3mA, which continues to flow when the 2120 is 'off'. If selecting a relay to wire in series with the 2120, the user must ensure that the drop-out voltage of the relay is greater than the voltage which will be generated across the relay coil when 3mA flows through it.

High level Dry = ON		Low level Wet = ON	
Dry On	Wet On	Dry On	Wet On
<p>LED on continuously</p>	<p>LED flashes every second</p>	<p>LED on continuously</p>	<p>LED flashes every second</p>

2120 PNP/PLC Version

- PNP output for load switching and direct PLC switching (3-wire, Yellow label)

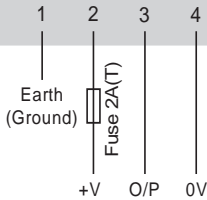
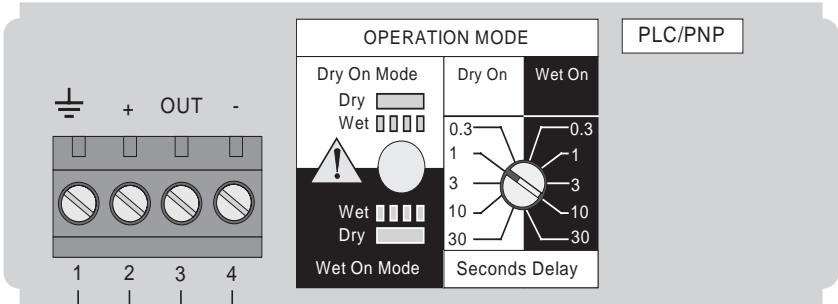

$$U = 20 - 60V \overline{\overline{\overline{\text{dc}}}}$$

$$I < 4mA + I_L$$

$$I_{L(MAX)} = 0 - 500mA$$

$$\hat{i} = 5A, 40ms$$

$$U_{OUT(ON)} = U - 2.5V$$

$$I_{L(OFF)} < 100\mu A$$

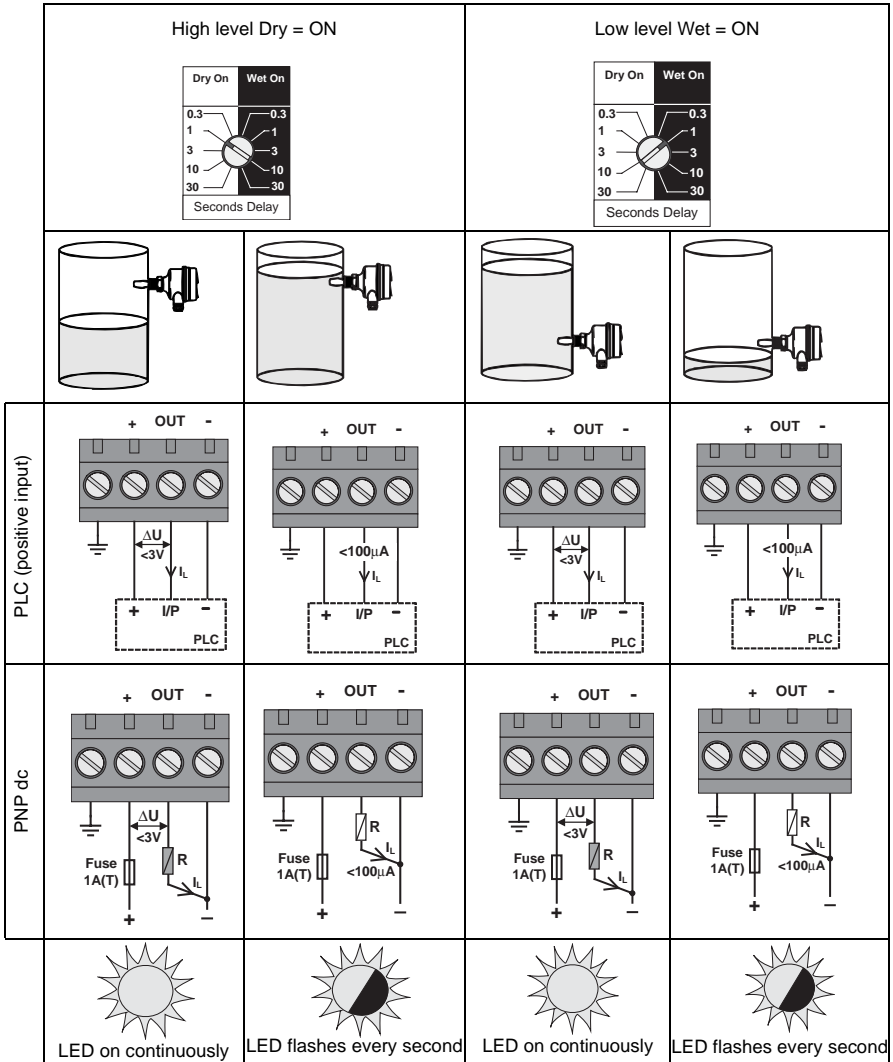

2120 Relay Output

- Relay output, SPCO (Green label)

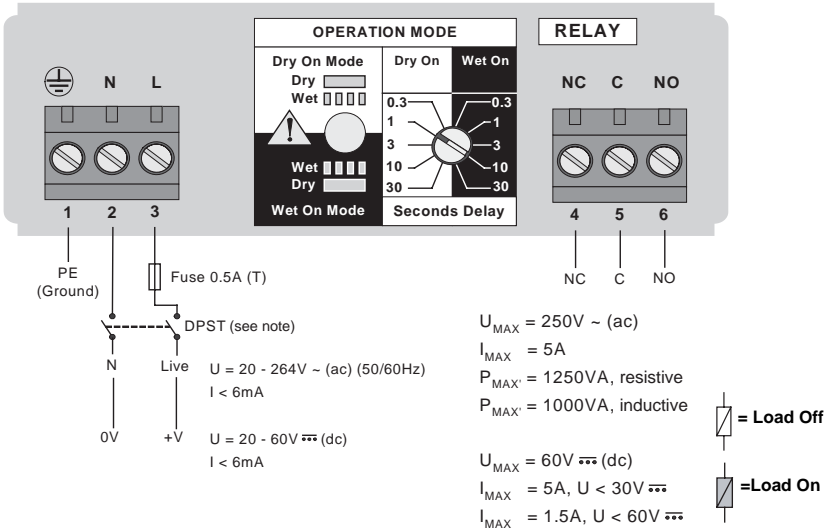

NOTE:

DPST = 'Double Pole, Single Throw' (on/off) switch - must be fitted for safe disconnection of the power supply. Fit the switch as near to the 2120 as possible. Keep the switch free of obstructions. Label the switch to indicate that it is the supply disconnection device for the 2120.

High level Dry = ON		Low level Wet = ON	
<p>Seconds Delay</p>		<p>Seconds Delay</p>	
<p>NC C NO</p>	<p>NC C NO</p>	<p>NC C NO</p>	<p>NC C NO</p>
LED on continuously	LED flashes every second	LED on continuously	LED flashes every second

2120 Intrinsically Safe NAMUR

- Intrinsically safe NAMUR (Blue label and cassette)

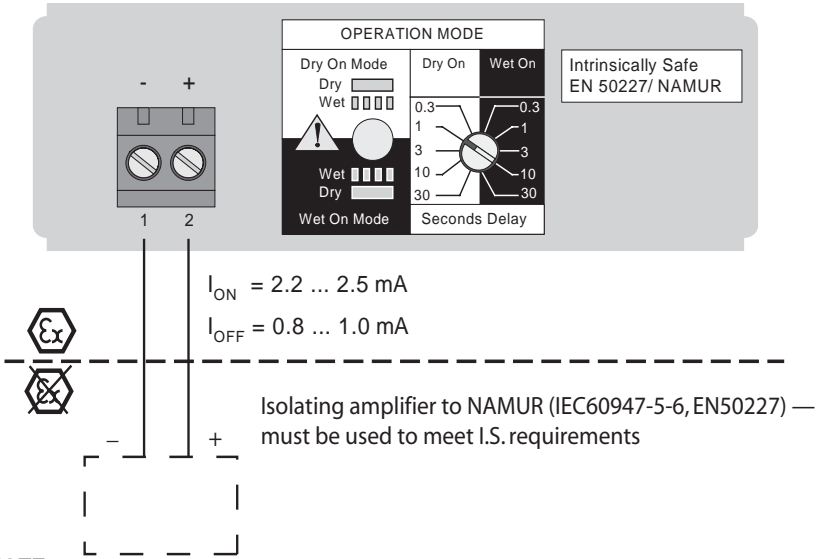

NOTE:

This I.S. cassette can not be interchanged with any other cassette.

High level Dry = ON		Low level Wet = ON	
LED on continuously	LED flashes every second	LED on continuously	LED flashes every second

SECTION 3 SERVICE & TROUBLESHOOTING

Magnetic Test Point	page 3-1
Inspection	page 3-2
2120 Maintenance	page 3-2
Troubleshooting	page 3-3
Spare Parts	page 3-3
Replacement and Calibration of Electronic (PCB) Cassettes	page 3-4

Magnetic Test Point

A magnetic test point is on the side of the housing allowing a functional test of the 2120. By touching a magnet on the target the 2120 output will change state for as long as the magnet is present.

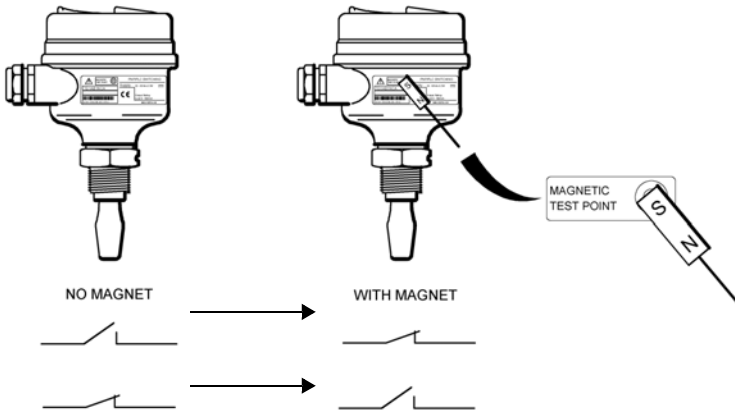

Rosemount 2120

Inspection

- Visually examine the 2120 for damage. If it is damaged, do not use.
- Ensure the lid and cable glands are fitted securely.
- Ensure the LED flash rate is 1 Hz or continually on. If anything else is demonstrated see “LED Indication” on page 2-6.

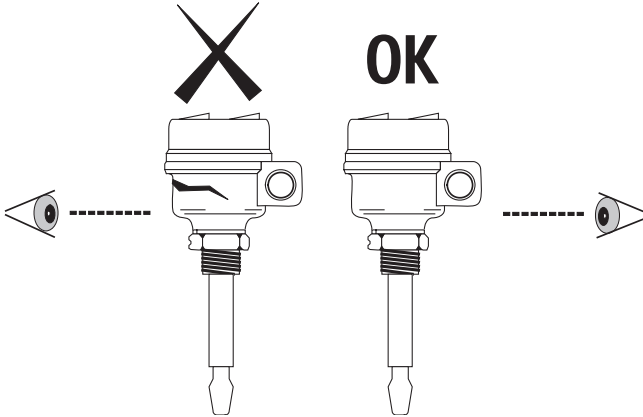

2120/2120_27aa.eps

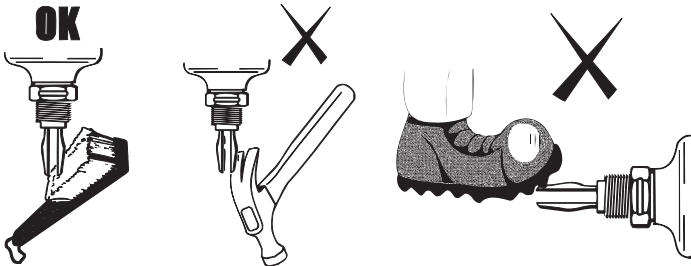
2120 Maintenance

2120/fig18a, fig18b, fig18c.eps

NOTE

If using a brush to clean, ensure it is of a soft type.

Troubleshooting

If there is a malfunction, see Table 3-1 for information on possible causes.

Table 3-1. Troubleshooting chart.

Fault	Symptom/Indication	Action/Solution
Does not switch	• No LED; no power	• Check the power supply; (check load on direct load switching electronics model)
	• LED 3 flashes per second	• Internal failure; contact supplier
	• LED 1 flash every 2 seconds	• Uncalibrated; return to supplier
	• LED 1 flash every 4 seconds	• Load fault; load current too high, load short circuit; check installation
	• Fork damaged	• Replace
	• Thick encrustation on forks	• Clean the fork with care
	• 5 second delay on changing mode/delay	• Wait 5 seconds
Incorrect switching	• Dry = On, Wet = On set correctly	• Set the correct mode on electronics insert
Faulty switching	• Turbulence	• Set a longer switching time delay
	• Excessive electrical noise	• Suppress the cause of the interference

Spare Parts

See "Spare Parts and Accessories" on page A-11.

Replacement and Calibration of Electronic (PCB) Cassettes

When replacing a damage or faulty cassette, it is necessary to calibrate the cassette with the operating frequency of the fork assembly. This is a list of actions required to enable calibration to occur. Please make sure you understand them prior to starting. Calibration sequence steps 3 to 13 are time dependent and must be carried out within the noted times. The time dependency and switching sequence is to prevent an accidental calibration occurring.

If this replacement is taking place in a (Potentially Explosive Atmosphere) Hazardous Area, a suitably qualified person must carry it out. All work in hazardous areas must be carried out in accordance to local code of practice. For general hazardous area requirements for this equipment, refer to Appendix B: Product Certifications.

This calibration routine takes a bit of practice; do not be surprised if the unit does not calibrate after the first attempt.

Replacement Sequence

On I.S. units, it is recommended that replacement and calibration be performed in a safe (non-hazardous) area.

NOTE:

I.S. cassettes can only be replaced with I.S. cassettes.

Non-I.S. cassette types can be interchanged with other non-I.S. cassettes, but a new label must be fitted and the original part number transferred to the new label.

Before starting the replacement and calibration procedure, ensure that any controlled process will not be adversely affected.

To replace the cassette, do the following:

1. Isolate and disconnect the power to the 2120. Insulate ends of the wires.

NOTE:

On relay units, there may be more than one power source.

2. Remove the screwed-on lid and disconnect the wires, noting connections (Figure 3-1). Also, note the exact Mode switch position (Figure 3-2) on the cassette that is to be replaced.
3. Remove and retain the two fixing screws from the base of the cassette and unplug the cassette.
4. Plug in the replacement cassette, refit the screws, reconnect the wires and set the Mode switch to Wet = ON with a one second delay (Figure 3-3).
5. Reconnect the power to the unit. (Reverse Step 1).

Figure 3-1. Cassette to be replaced.

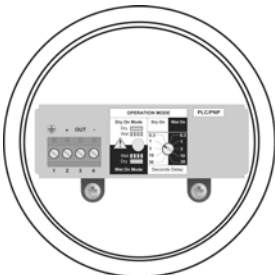

Figure 3-2. Mode switch set to Dry = ON, 1 second delay. This is an example of how the existing cassette may look. Take note of the actual setting.

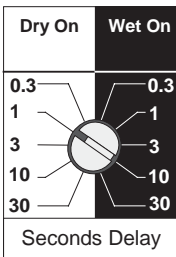
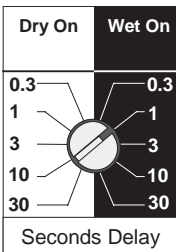

Figure 3-3. Mode switch of replacement cassette set to Wet = ON, 1 second delay.



NOTE:
 Switching time delay: 0.3, 1, 3, 10 or 30 seconds (mode switch selection)
 Status Indication LED: On continuous: Output ON
 One flash per second: Output OFF
 One flash every 4 seconds: Load Fault (Current too high, short circuit or load omitted)

Rosemount 2120

Calibration Sequence

To calibrate the cassette, do the following:

1. Ensure that the sensor forks are dry and the mode switch is set to Wet = On, time delay 1 second.
2. Check that the LED is flashing at one flash per second. If it is on continuously, proceed to step 8.
3. Apply magnet to test point. With the housing conduit nearest to you, the test point can be found halfway down the housing on the right hand side in line with the PCB cassette. On the external housings, a target indicates this. (see page 3-1).
4. After a one second delay, the LED will light continuously.
5. Within three seconds rotate the Mode switch two steps clockwise.
6. After a two second delay, the LED will go out.
7. Within three seconds, rotate the Mode switch two steps anti-clockwise. Proceed to step 13.
8. Apply magnet to test point, indicated by a target on external label (see page 3-1).
9. After a one second delay, the LED will flash at one flash per second.
10. Within three seconds, rotate the Mode switch two steps clockwise.
11. After a two second delay, the LED will go out (stop flashing).
12. Within three seconds, rotate the Mode switch two steps anti-clockwise.
13. After a two second delay, the LED should flash twice per second.
14. If the LED is flashing twice per second, the calibration has occurred correctly. Remove the magnet. After a one second delay, the unit will return to normal operation. Proceed to step 17.
15. If the LED is flashing once per second or it is on continuously, the calibration has failed. If this occurs, remove the magnet, wait ten seconds and then repeat from step 2 onwards.
16. If the LED stays off after the two second delay of step 13, the sensor is not working correctly. Check that the sensor forks are clean and dry. Also, check that there is nothing jammed in or touching the sensor. If no fault is found with the sensor, the entire unit should be returned for repair.
17. Set the Mode switch to the original setting noted in step 2 of the Replacement Sequence. Wait five seconds for the new setting to be acted upon.
18. Replace the lid and check the system works.

APPENDIX A REFERENCE DATA

Specifications page A-1
Dimensional Drawings page A-5
Ordering Information page A-8

Specifications

Physical

Product

Rosemount 2120 Liquid Level Switch

Measuring principle

Vibrating Fork

Applications

Most liquids including coating liquids, aerated liquids, and slurries

Mechanical

Housing/Enclosure

Housing Code	A	D	X	Y	S	T
Housing material	Nylon PA66 30%GF		Al alloy ASTM B26 356-T6 or LM25 TF		316C12 Stainless Steel	
LED Window	PMMA		none		none	
Conduit Entry	M20	1/2-in. NPT	M20	3/4-in. NPT	M20	3/4-in. NPT
Ingress Protection	IP66/67 to EN60529		IP66/67 to EN60529, NEMA 4X		IP66/67 to EN60529, NEMA 4X	

Connections

See "Process Connection Size / Type" on page A-8

Extended Lengths

Available as standard to a maximum 118-in. (3000 mm), other on request

Process Material

316L Stainless Steel (1.4404), Hastelloy C or Halar (ECTFE) / PFA co-polymer coating (39.37-in. [1000 mm] max). Hand polished to better than 0.8µm option available for hygienic connections. Gasket material for 3/4-in. and 1-in. BSPP (G) is Non-asbestos BS7531 Grade X carbon fiber with rubber binder.

Dimensional Drawings

See "Dimensional Drawings" on page A-5



Rosemount 2120

Performance

Hysteresis (water)

±0.039-in. (± 1mm) nom.

Switching Point (water)

0.5-in. (13 mm) from tip (vertical) / from edge (horizontal) of fork
(this will vary with different liquid densities).

Functional

Maximum Operating Pressure

Final rating depends on tank connection

Threaded Connection

See Figure A-1.

Note: Clamp gland (02120-2000-0001), see page A-11, limits the maximum operating pressure to 18.85 psig (1.3 barg).

Hygienic Connection

435 psig (30 barg)

Flanged Connection

See Figure A-1 and Table A-1 (whichever one is lower).

Table A-1. Maximum Flange Pressure Rating

Standard	Class/Rating	SST Flanges
ANSI	150 lb.	275 psig ⁽¹⁾
ANSI	300 lb.	720 psig ⁽¹⁾
ANSI	600 lb.	1,440 psig ⁽¹⁾
DIN	PN 10/16	10/16 barg ⁽²⁾
DIN	PN 25/40	25/40 barg ⁽²⁾
DIN	PN 64	64 barg ⁽²⁾
DIN	PN 100	100 barg ⁽²⁾

(1) At 100°F (38°C), the rating decreases with increasing temp.

(2) At 248°F (120°C), the rating decreases with increasing temp.

Figure A-1. Process Pressure

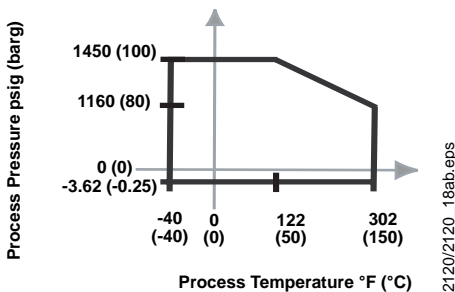

Reference Manual

00809-0100-4030, Rev AA
July 2005

Rosemount 2120

Temperature

See Figure A-2.

Figure A-2. Temperature

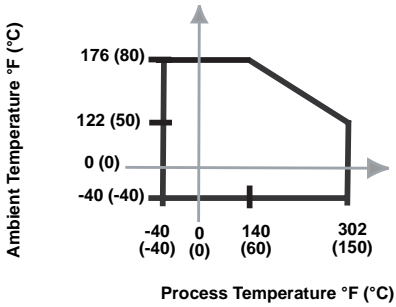

2120/2120_18ac.eps

Liquid Density

Minimum 37.5 lb/ft³ (600 kg/m³)

Liquid Viscosity Range

0.2 to 10,000 cP (centiPoise)

Solids Content and Coating

Maximum recommended diameter of solid particles in the liquid is 0.2-in. (5 mm).
For coating product, avoid bridging of forks.

Switching Delay

User selectable 0.3, 1, 3, 10, 30 seconds delay dry to wet/wet to dry

CIP (Clean In Place) Cleaning

Withstands steam cleaning routines up to 302°F (150°C)

Rosemount 2120

Electrical

Switching Mode

User selectable (Dry = on or Wet = on)

Protection

Reverse polarity insensitive. Missing load / short circuit protection

Terminal Connection (wire diameter)

Max. 0.1-in² (2.5 mm²) (Note national regulations)

Conduit Plugs/Cable Gland

Metal EE xd Housing:

- Conduit entries for explosion proof areas are shipped with two brass conduit plugs.

Plastic Housing:

- The direct load, PNP/PLC and IS electronics are shipped with one PA66⁽¹⁾ cable gland and one blanking plug.
- The relay units are shipped with two PA66⁽¹⁾ cable glands.

Grounding

The 2120 should always be grounded either through the terminals or using the external ground connection provided.

Electrical Connections

- Direct load switching (two-wire)
- Solid state PNP output for direct interface to PLC's (three wire)
- SPCO single relay for voltage free contacts
- Intrinsically Safe (IS) NAMUR to DIN 19234, IEC 60947-5-6

(1) Cable diameter 0.2 to 0.3-in. (5 to 8 mm)

Dimensional Drawings
Threaded Mounting

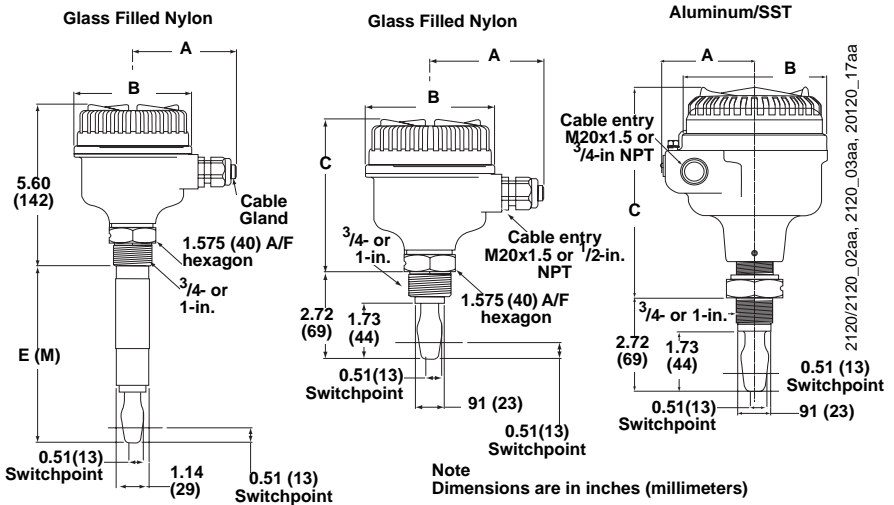

Table A-2. Fork Length. Dimensions are in inches (millimeters)

Thread	Standard Length Code A	Minimum Length Code E (M)	Maximum Length Code E (M)
3/4-in.	1.73 (44)	3.74(95)	118.11 (3000)
1-in.	1.73 (44)	3.70 (94)	118.11 (3000)

Table A-3. Housing Dimensions. Dimensions are in inches (millimeters)

Material	A	B	C
Glass Nylon	3.52 (90)	4.02 (102)	4.72 (120)
Aluminum	2.76 (70)	4.13 (105)	6.30 (160)
316 Stainless Steel	2.76 (70)	4.13 (105)	6.30 (160)

Rosemount 2120

Flange Mounting

Glass filled nylon housing shown.

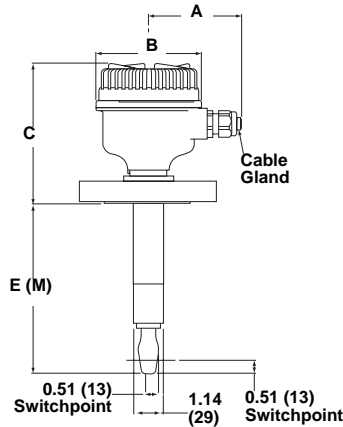

Note
Dimensions are in
inches (millimeters)

2120/2120_09aa.eps

Table A-4. Dimensions are in inches (millimeters)

Material	Standard Length Code H	Minimum Length Code E (M)	Maximum Length Code E (M)
Stainless Steel	4 (102)	3.50 (89)	118.11 (3000)
Halar/PFA co-polymer coated	4 (102)	3.50 (89)	39.37 (1000)

Table A-5. Housing Dimensions. Dimensions are in inches (millimeters)

Material	A	B	C ⁽¹⁾
Glass Nylon	3.52 (90)	4.02 (102)	6.30 (160)
Aluminum	2.76 (70)	4.13 (105)	7.87 (200)
Stainless Steel	2.76 (70)	4.13 (105)	7.87 (200)

(1) Will vary with flange rating and thickness. "C" is nominal maximum thickness and allows a flange up to 1.77-in. (45 mm) thick. This equates to a 4-in. ANSI, 600lb. RF.

Hygienic Fitting

Glass filled nylon housing shown.

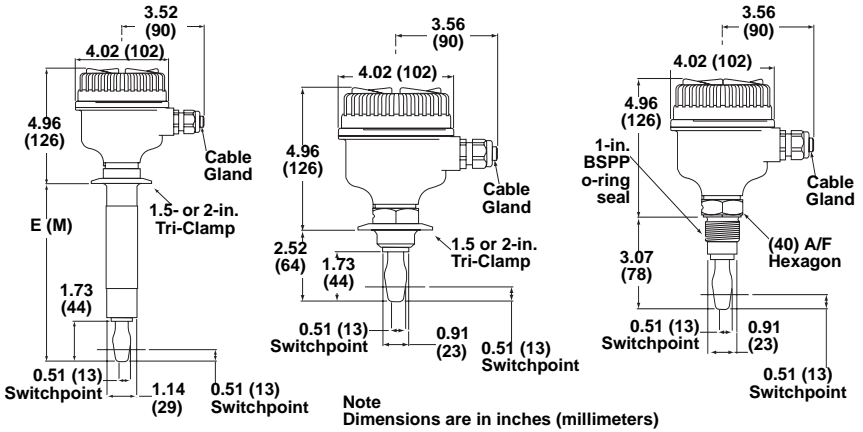

2120/2120_05aa, 2120_10aa, 2120_20aa.eps

Table A-6. Dimensions are in inches (millimeters)

Connection	Standard Length Code A	Minimum Length Code E (M)	Maximum Length Code E (M)
Tri-Clamp	1.7 (44)	4.13 (105)	118.11 (3000)
O-ring Seal (1-in. BSPP)	1.7 (44)	NA	NA

Rosemount 2120

Ordering Information

Model	Product Description
2120	Vibrating Fork Liquid Level Switch
Code	Material of Construction: Process Connection/Fork
D	316L Stainless Steel (1.4404)
N ⁽¹⁾⁽²⁾	316L SST (1.4404) with NACE compliance to MR 0175:2003 (ISO 15156:2003), MR 0103-2003
F ⁽³⁾	Halar/PFA, coated 316L SST (1.4404)
C ⁽⁴⁾	Hastelloy C, solid Hastelloy
Code	Process Connection Size / Type
	Threaded
0A	³ / ₄ -in. BSPT (R) thread
0B	³ / ₄ -in. BSPP (G) thread
0D	³ / ₄ -in. NPT thread
1A	1-in. BSPT (R) thread
1B	1-in. BSPP (G) thread
1D	1-in. NPT thread
	Hygienic Fitting
1P	1-in. BSPP (G), O-ring
5R	1.5-in. (38 mm) Tri-Clamp
2R	2-in. (51 mm) Tri-Clamp
	ANSI Flanges
5G	1.5-in. ANSI, 150 lb. RF
5H	1.5-in. ANSI, 300 lb. RF
5J	1.5-in. ANSI, 600 lb. RF
2G	2-in. ANSI, 150 lb. RF
2H	2-in. ANSI, 300 lb. RF
2J	2-in. ANSI, 600 lb. RF
3G	3-in. ANSI, 150 lb. RF
3H	3-in. ANSI, 300 lb. RF
3J	3-in. ANSI, 600 lb. RF
4G	4-in. ANSI, 150 lb. RF
4H	4-in. ANSI, 300 lb. RF
4J	4-in. ANSI, 600 lb. RF

Reference Manual

00809-0100-4030, Rev AA
July 2005

Rosemount 2120

DIN (EN) Flanges

5K	DN40, PN 10/16
5L	DN40, PN 25/40
5M	DN40, PN 64
5N	DN40, PN 100
2K	DN50, PN 10/16
2L	DN50, PN 25/40
2M	DN50, PN 64
2N	DN50, PN 100
7K	DN65, PN 10/16
7L	DN65, PN 25/40
7M	DN65, PN 64
7N	DN65, PN 100
3K	DN80, PN 10/16
3L	DN80, PN 25/40
3M	DN80, PN 64
3N	DN80, PN 100
4K	DN100, PN 10/16
4L	DN100, PN 25/40
4M	DN100, PN 64
4N	DN100, PN 100

Other Process Connection

XX⁽⁵⁾ Customer Specific

Code	Electronic Type	Available for Certifications
S	Direct load switching (2 wire) 20 to 264Vac 50/60Hz, 20 to 60 Vdc	NA, E1, E5, G5
B	PNP/PLC low voltage switching (3 wire) 20 to 60Vdc	NA, E1, E5, G5
R	Relay (SPDT/SPCO)	NA, E1, E5, G5
C	IS NAMUR (EEx ia) (wetted parts)	I1, I5

Code	Surface Finish (wetted parts)	Available for Connections
1	Standard surface finish	All
2	Hand polished (Ra <0.8 µm)	Hygienic Connection Only

Code	Product Certifications	Available for Electronic	Available for Housing
NA	No Hazardous Locations Certifications	S, B, R	A, D
G5 ⁽⁶⁾	FM Ordinary Locations (unclassified, safe area)	S, B, R	Y, T
E1	ATEX Flameproof	S, B, R	X, S
E5 ⁽⁶⁾	FM Explosion Proof	S, B, R	Y, T
I1	ATEX Intrinsic Safety	C	A, D
I5	FM Intrinsic Safety	C	A, D

Code	Housing	Available for Certifications
A	Glass Filled Nylon, M20 conduits/cable threads	NA, I1, I5
D	Glass Filled Nylon, 1/2-in. NPT conduits/cable threads	NA, I1, I5
X	Aluminum Alloy, M20 conduits/cable threads	E1
Y	Aluminum Alloy, 3/4-in. NPT conduits/cable threads	E5, G5
S	Stainless Steel M20 conduits/cable threads	E1
T	Stainless Steel 3/4-in. NPT conduits/cable threads	E5, G5

Rosemount 2120

Code	Fork Length	Available Connection
A	Standard length 1.7-in. (44 mm)	All except flanged models
H ⁽²⁾	Standard length flange 4.0-in. (102 mm)	All flanged models
B ⁽²⁾	Ext 5.9-in. (150 mm)	All except Tri-clamp 5R and 2R
C ⁽²⁾	Ext 11.8-in. (300 mm)	All except Tri-clamp 5R and 2R
D ⁽²⁾	Ext 19.7-in. (500 mm)	All except Tri-clamp 5R and 2R
L ⁽⁷⁾	Semi-ext 4.6-in. (116 mm)	1A, 1B, and 1D
Specific Extended Fork Length		
E ⁽⁸⁾	Extended, Customer Specified Length in Tenth of Inches	All except 1-in. BSPP O-ring seal 1P.
M ⁽⁸⁾	Extended, Customer Specified Length in Millimeters	All except 1-in. BSPP O-ring seal 1P.
xxxx ⁽⁸⁾	Specific customer specified length in inches or millimeters (only if fork length E or M is selected)	
Code	Options	
Calibration Data Certification		
Q4	Certificate of functional test	
Material Traceability Certification		
Q8 ⁽¹⁾⁽²⁾	Material Traceability Certification per EN 10204 3.1B	
Special Procedures		
P1 ⁽⁹⁾	Hydrostatic testing	
Overfill		
U1 ⁽¹⁰⁾	DIBt/WHG Overfill protection	
Tag Plates		
ST	Tag plate SST engraved plate (maximum 16 digits)	
WT	Tag plate hand written waxed paper (maximum 40 digits)	

Typical Model: 2120 D 0A C 1 I1 A A Q8 ST

- (1) Only available for wetted parts.
 - (2) Not available for hand polished wet side.
 - (3) Halar/PFA copolymer coating is not available on threaded options.
 - (4) Only available of BSPT and NPT threaded process connection code 0A, 0D, 1A, and 1D as standard.
Other upon request.
 - (5) Other process connections available upon request.
 - (6) See Appendix B: Product Certifications. E5 includes G5 requirements. G5 is for use in unclassified, safe area locations only.
 - (7) Only available with stainless steel material of construction D and glass nylon housing A and D.
 - (8) Minimum length available for connection ³/₄-in. threaded is 3.8-in. (95 mm), for 1-in. threaded is 3.7-in. (94 mm), for flanged is 3.5-in. (89 mm) and Tri-Clamp is 4.1-in. (105 mm). Maximum length up to 118.1-in. (3000 mm) except for Halar/PFA copolymer coating and hand polished process is 39.4-in. (1000 mm).
- Example: Code E1181 is 118.1 inches.
Code M3000 is 3000 millimeters.
- (9) Option limited to units of no more than 59.1-in. (1500 mm) extended lengths.
Option not available for Halar/PFA coating.
 - (10) Option not available for Stainless Steel housing code S and T.

Reference Manual

00809-0100-4030, Rev AA
July 2005

Rosemount 2120

Spare Parts and Accessories

Part Number	Spares and Accessories
-------------	------------------------

02100-1000-0001	Seal for 1-in. BSPP (G1A). Material: Non-asbestos BS7531 grade X carbon fiber with rubber binder
-----------------	---

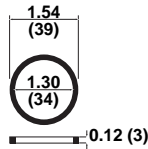

02100-1010-0001	Hygienic adaptor boss 1-in. BSPP. Material: 316 SS fitting. Viton 'O' ring
-----------------	--

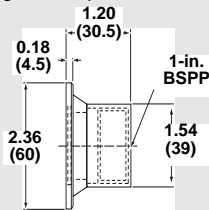

02100-1020-0001	2-in. (51 mm) Tri-clamp kit including vessel fitting, clamp ring, seal. Material: 316 St. steel, NBR Nitrile
-----------------	---



02100-1030-0001	Telescopic test magnet
-----------------	------------------------

02100-1040-0001	Seal for 3/4-in. BSPP (G3/4A) Material: Non-asbestos BS7531 grade X carbon fiber with rubber binder.
-----------------	---

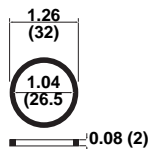

02120-2000-0001	Adjustable clamp gland for 1-in. extended lengths. Material: 316 At. steel, (Si) Silicone rubber seal
-----------------	--

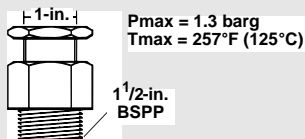

Rosemount 2120

Part Number Spares and Accessories		
Part Number	Replacement Cassettes	Available for Housing
02120-3000-0001	Direct load switching (2 Wire) (Red) (See page 2-7)	A, D
02120-3010-0001	PNP/PLC cassette (Yellow) (See page 2-9)	A, D
02120-3020-0001	Intrinsically safe cassette (Blue) (See page 2-13)	A, D
02120-3030-0001	Relay output cassette (Green) (See page 2-11)	A, D
02120-3040-0001	FM Exd Direct load switching (2 Wire) (Red) (See page 2-7)	X, Y, S, T
02120-3050-0001	FM Exd PNP/PLC cassette (Yellow) (See page 2-9)	X, Y, S, T
02120-3060-0001	FM Exd Relay output cassette (Green) (See page 2-11)	X, Y, S, T

NOTE:

I.S. cassettes can only be replaced with I.S. cassettes. Non-I.S. cassette types can be interchanged with other non-I.S. cassettes, but the new label must be fitted and the original part number transferred to the new label.

APPENDIX B PRODUCT CERTIFICATIONS

Approved Manufacturing Locations	page B-1
Ordinary Location Certification for FM	page B-1
European Directive Information	page B-1
Overfill protection	page B-1
Hazardous Locations Certifications	page B-2
North American Approvals	page B-2
European Approvals	page B-7

Ordinary Location Certification for FM

G5 The switch has been examined and tested to determine that the design meets basic electrical, mechanical, and fire protection requirements by FM, a nationally recognized testing laboratory (NRTL) as accredited by the Federal Occupational Safety and Health Administration (OSHA).

European Directive Information

The EC declaration of conformity for all applicable European directives for this product can be found on the Rosemount website at www.rosemount.com. A hard copy may be obtained by contacting your local sales office.

ATEX Directive (94/9/EC)

Complies with the ATEX Directive.

Pressure Equipment Directive (PED) (97/23/EC)

2120 is outside the scope of PED Directive.

L.V. Directive

EN61010-1 Pollution degree 2, Category II (264V max), Pollution degree 2, Category III (150V max)

Electro Magnetic Compatibility (EMC) Directive

EN61326 Emissions to Class B.

Immunity to industrial location requirements.

Vibration Resistance

EN60721 level 3M6/4M6

CE-mark

Complies with applicable directives (EMC, ATEX)

Overfill protection

Option available for DIBt/WHG

Approved Manufacturing Locations

Slough, UK

Rosemount 2120

Hazardous Locations Certifications**North American Approvals****Factory Mutual (FM) Explosion Proof Approval**

E5 Project ID: 3024095
 Explosion Proof for Class I, Div. 1, Groups A, B, C and D
 Temperature Class:
 T6 (T_{amb} -40°C to +75°C)

Enclosure: Type 4X

Instructions specific to hazardous area installations

1. The equipment may be used with flammable gases and vapors with apparatus Class 1, Div 1, Groups A, B, C and D.
2. The equipment is certified for use in ambient temperatures of -40°F to +176°F (-40°C to +80°C) and with a maximum process temperature of 150°C.
3. Installation of this equipment shall be carried out by suitably trained personnel, in accordance with the applicable code of practice.
4. Inspection and maintenance of this equipment shall be carried out by suitably trained personnel, in accordance with the applicable code of practice.
5. The user should not repair this equipment.
6. The certification of this equipment relies upon the following materials used in its construction:

Body: Aluminum Alloy ASTM B26 356-T6 or LM25 TF or
 Stainless Steel 316C12

Lid: Aluminum Alloy ASTM B26 356-T6 or LM25 TF or
 Stainless Steel 316C12

Switch: Stainless steel 316 Type or Hastelloy C276 UNS N10276 or equivalent

Switch Filling: Perlite

Lid Seal: Silicone

If the equipment is likely to come into contact with aggressive substances, it is the responsibility of the user to take suitable precautions that prevent it from being adversely affected, thus ensuring that the type of protection is not compromised.

Aggressive substances: e.g. acidic liquids or gases that may attack metals, or
 solvents that may affect polymeric materials

Suitable precautions: e.g. regular checks as part of routine inspections or
 establishing from the material's data sheet that it is resistant
 to specific chemicals

NOTE:

The metallic alloy used for the enclosure material may be at the accessible surface of this equipment; in the event of rare accidents, ignition sources due to impact and friction sparks could occur. This shall be considered when the 2120 is installed in locations that specifically require Class 1, Div 1 equipment.

7. It is the responsibility of the user to ensure:
 - a. That the joint requirements between the switch and the vessel tank are compatible with the process media.
 - b. That the joint tightness is correct for the joint material used.
8. The switch fork is subjected to small vibration stresses as part of its normal function. As this provides a partition wall, it is recommended that the fork should be inspected every 2 years for signs of defects.
9. It is the responsibility of the user to ensure that only suitably certified cable entry devices will be used when connecting this equipment.
10. Technical data:
 Coding: Class 1, Div 1, Groups A, B, C, and D
 T6 (Ta = -40°F to + 167°F [-40°C to + 75°C])
 T4 (Ta = -40°F to + 257°F [-40°C to +125°C])
 T3 (Ta = -40°F to + 302°F [-40°C to +150°C])
 Ta = the higher of the process or ambient temperature.

For electrical details and pressure ratings, refer to Section 2: Installation and Appendix A: Reference Data.

11. Label and certification plate details. Typical arrangement shown. Sensor specific details omitted.



2120_32aa.eps

12. Cable selection:
 It is the responsibility of the user to ensure that suitably temperature rated cable is used. The table below is a guide to selection:

T Class	Cable Temperature Rating
T6	Above 185°F (85°C)
T5	Above 212°F (100°C)
T4	Above 275°F (135°C)
T3	Above 320°F (160°C)

13. Conduits:
 Seal all conduits at enclosure wall.

Rosemount 2120

Factory Mutual (FM) Intrinsically Safe Approval

- 15** Project ID: 3024095
 Intrinsically Safe for Class I, Div. 1, Groups A, B, C and D
 Class I, Zone 0, AEx ia IIC
 Temperature Code:
 T5 (T_{amb} -40°C to +80°C, T_{proc} < 80°C)
- Control Drawing: 71097/1154
 Ui=15 V, Ii=32 mA, Pi=0.1 W, Ci=211 nF, Li=0.06 mH

NOTE

A NAMUR isolating amplifier must be used for intrinsic safety.

Instructions specific to hazardous (classified locations) area installations

Model numbers covered: 2120XXXCXI5XX

("X" indicates options in construction, function and materials.)

The following instructions apply to equipment covered by

Factory Mutual Research Approval:

1. The Rosemount 2120 I.S. may be used in a hazardous locations with flammable gases and vapors Class 1 Division 1 Groups ABC and D, and Class 1 Zone 0 Group IIC when installed in accordance with control drawing 71097/1154.
2. The apparatus electronics is only certified for use in ambient temperatures in the range of -40°C to +80°C. It should not be used outside this range. However, the switch may be located in the process medium which may be at a higher temperature than the electronics but must not be higher than the Temperature Class for the respective process gas/medium.

Process Temperature	Temperature classes
176°F (80°C)	T1, T2, T3, T4, T5
239°F (115°C)	T1, T2, T3, T4,
302°F (150°C)	T1, T2, T3

It is a condition of the Approval that the temperature of the electronics housing is in the range of -40°F to +176°F (-40°C to +80°C). It must not be used outside this range. It will be necessary to limit the external ambient temperature if the process temperature is high. (See Technical Data below.)

3. Suitably trained personnel shall carry out installation in accordance with the applicable code of practice.
4. The user should not repair this equipment.
5. If the equipment is likely to come into contact with aggressive substances, it is the responsibility of the user to take suitable precautions that prevent it from being adversely affected, thus ensuring that the type of protection is not compromised.

Aggressive Substances – e.g. acidic liquids or gases that may attack metals or solvents that may affect polymeric materials.

Suitable Precautions – e.g. regular checks as part of routine inspections or establishing from the material's data sheet that it is resistant to specific chemicals.

6. If the enclosure is made of an alloy or plastic material, the following precautions must be observed:
- a. The metallic alloy used for the enclosure material may be at the accessible surface of this equipment; in the event of rare accidents, ignition sources due to impact and friction sparks could occur.
 - b. Under certain extreme circumstances, the non-metallic parts incorporated in the enclosure of the Rosemount 2120 may generate an ignition-capable level of electrostatic charge. Therefore, when they are used for applications that specifically require group II equipment, the Rosemount 2120 shall not be installed in a location where the external conditions are conducive to the build-up of electrostatic charge on such surfaces. Additionally, the Rosemount 2120 shall only be cleaned with a damp cloth.
7. Technical Data:

Approval: Class 1 Division 1 Groups ABC and D

Class 1 Zone 0 AEx ia IIC

T5 (Ta = -40°F to +176°F [-40°C to +80°C])

T4 (Ta = -40°F to +239°F [-40°C to +115°C])

T3 (Ta = -40°F to +302°F [-40°C to +150°C])

Ta = the higher of the process or ambient temperature.

Input parameters: Vmax:15V, Imax:32mA, Pi:100mW, Ci:211nF, Li:60μH

Temperature:Process (Tp) -40°C to 150°C

External (Ta) -40°C to +80°C (up to Tp=80°C, reducing linearly to 50°C at Tp=150°C)

Materials: Refer to Part numbering identification chart.

European Approvals

ATEX Flame Proof Approvals

E1 Certificate: Sira 05ATEX1129
Flame Proof:
ATEX Marking  II 1/2 G D
EEx d IIC T6 (T_v -40°C to +75°C)

Instructions specific to hazardous area installations

(Reference European ATEX Directive 94/9/EC, Annex II, 1.0.6.)

The following instructions apply to the 2120 covered by certificate number Sira 05ATEX1129:

1. The equipment may be used with flammable gases and vapors with apparatus groups IIA, IIB & IIC and with temperature classes T1, T2, T3, T4, T5 & T6.
2. The equipment is certified for use in ambient temperatures of -40°C to +80°C and with a maximum process temperature of 150°C.
3. The equipment has not been assessed as a safety related device (as referred to by Directive 94/9/EC Annex II, clause 1.5).
4. Installation of this equipment shall be carried out by suitably trained personnel, in accordance with the applicable code of practice.
5. Inspection and maintenance of this equipment shall be carried out by suitably trained personnel, in accordance with the applicable code of practice.
6. The user should not repair this equipment.
7. The certification of this equipment relies upon the following materials used in its construction:
Body: Aluminum Alloy ASTM B26 356-T6 or LM25 TF or Stainless Steel 316C12
Lid: Aluminum Alloy ASTM B26 356-T6 or LM25 TF or Stainless Steel 316C12
Switch: Stainless steel 316 Type or Hastelloy C276 UNS N10276 or equivalent
Switch Filling: Perlite
Lid Seal: Silicone

If the equipment is likely to come into contact with aggressive substances, it is the responsibility of the user to take suitable precautions that prevent it from being adversely affected, thus ensuring that the type of protection is not compromised.

Aggressive substances:e.g. acidic liquids or gases that may attack metals, or solvents that may affect polymeric materials

Suitable precautions:e.g. regular checks as part of routine inspections or establishing from the material's data sheet that it is resistant to specific chemicals

Note:

The metallic alloy used for the enclosure material may be at the accessible surface of this equipment; in the event of rare accidents, ignition sources due to impact and friction sparks could occur. This shall be considered when the 2120 is being installed in locations that specifically require group II, category 1G equipment.

8. It is the responsibility of the user to ensure:
 - a. That the joint requirements between the switch and the vessel tank are compatible with the process media.
 - b. That the joint tightness is correct for the joint material used.
9. The switch fork is subjected to small vibration stresses as part of its normal function. As

Rosemount 2120

this provides a partition wall, it is recommended that the fork should be inspected every 2 years for signs of defects.

10. It is the responsibility of the user to ensure that only suitably certified cable entry devices will be utilized when connecting this equipment.

11. Technical data:

Coding: II 1/2 G D

EEx d IICT6 (Ta = -40°C to + 75°C)

T4 (Ta = -40°C to +125°C)

T3 (Ta = -40°C to +150°C)

Ta = the higher of the process or ambient temperature.

For electrical details and pressure ratings, refer to Section 2: Installation and Appendix A: Reference Data.

12. Label and certification plate details.

Typical arrangement shown. Sensor specific details omitted.

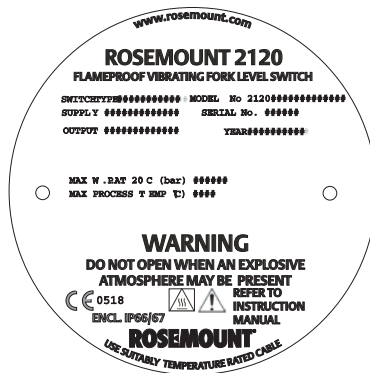

13. Cable selection.

It is the responsibility of the user to ensure that suitably temperature rated cable is used. The table below is a guide to selection:

T Class	Cable Temperature Rating
T6	85°C
T5	100°C
T4	135°C
T3	160°C

ATEX Intrinsically Safe Approval

I1 Certificate: Sira 05ATEX2130X
 Intrinsic Safety:
 ATEX Marking  II 1 G D
 EEx ia IIC T5 (T_{amb} -40°C to +80°C)

Ui=15 V, Ii=32 mA, Pi=0.1 W, Ci=12 nF, Li=0.06 mH

NOTE

A NAMUR isolating amplifier must be used for intrinsic safety.

Instructions specific to hazardous area installations

Model numbers covered: 2120XXCXI1XX

("X" indicates options in construction, function and materials.)

The following instructions apply to equipment covered by certificate number Sira 05ATEX2130X:

1. The 2120 I.S. may be used in a hazardous area with flammable gases and vapors with apparatus groups IIC, IIB and IIA and with temperature classes T1, T2, T3, T4 and T5.
2. The apparatus electronics is only certified for use in ambient temperatures in the range of -40°C to +80°C. It should not be used outside this range. However, the switch may be located in the process medium which may be at a higher temperature than the electronics but must not be higher than the Temperature Class for the respective process gas/medium.

Process Temperature	Temperature classes
80°C	T1, T2, T3, T4, T5
115°C	T1, T2, T3, T4,
150°C	T1, T2, T3

It is a special condition of the certification that the temperature of the electronics housing is in the range of -40°C to +80°C. It must not be used outside this range. It will be necessary to limit the external ambient temperature if the process temperature is high. (See Technical Data below.)

3. Suitably trained personnel shall carry out installation in accordance with the applicable code of practice.
4. The user should not repair this equipment.
5. If the equipment is likely to come into contact with aggressive substances, it is the responsibility of the user to take suitable precautions that prevent it from being adversely affected, thus ensuring that the type of protection is not compromised.

Aggressive Substances – e.g. acidic liquids or gases that may attack metals or solvents that may affect polymeric materials.

Suitable Precautions – e.g. regular checks as part of routine inspections or establishing from the material's data sheet that it is resistant to specific chemicals.

Rosemount 2120

6. If the enclosure is made of an alloy or plastic material, the following precautions must be observed:
- The metallic alloy used for the enclosure material may be at the accessible surface of this equipment; in the event of rare accidents, ignition sources due to impact and friction sparks could occur. This shall be considered when the 2120 is being installed in locations that specifically require group II, category 1G equipment.
 - Under certain extreme circumstances, the non-metallic parts incorporated in the enclosure of the 2120 may generate an ignition-capable level of electrostatic charge. Therefore, when they are used for applications that specifically require group II, category 1 equipment, the 2120 shall not be installed in a location where the external conditions are conducive to the build-up of electrostatic charge on such surfaces. Additionally, the 2120 shall only be cleaned with a damp cloth.
7. Technical Data:

Coding: II 1 G D, EEx ia IIC T5 ($T_a = -40^{\circ}\text{C}$ to $+80^{\circ}\text{C}$)

T4 ($T_a = -40^{\circ}\text{C}$ to $+115^{\circ}\text{C}$)

T3 ($T_a = -40^{\circ}\text{C}$ to $+150^{\circ}\text{C}$)

T_a = the higher of the process or ambient temperature.

Input parameters: U_i :15V, I_i :32mA, P_i :100mW, C_i :12nF, L_i :60 μ H

Temperature: Process (T_p) -40°C to 150°C

External (T_a) -40°C to $+80^{\circ}\text{C}$ (up to $T_p=80^{\circ}\text{C}$, reducing linearly to 50°C at $T_p=150^{\circ}\text{C}$)

Materials: Refer to Part numbering identification chart.

*Cover Photos: 2120/2120 ext plas_rev, 2120_04aa.tif.
Rosemount and the Rosemount logotype are registered trademarks of Rosemount Inc.
VITON is a registered trademark of E.I. du Pont de Nemours & Co.
Hastelloy and Hastelloy C are registered trademarks of Haynes International.
All other marks are the property of their respective owners.*

**Emerson Process Management
Rosemount Inc.**

8200 Market Boulevard
Chanhassen, MN USA 55317
T (US) (800) 999-9307
T (Intl) (952) 906-8888
F (952) 949-7001

Emerson Process Management

Heath Place
Bognor Regis
West Sussex PO22 9SH
England
Tel 44 (1243) 863 121
Fax 44 (1243) 867 5541

**Emerson Process Management
Asia Pacific Private Limited**

1 Pandan Crescent
Singapore 128461
T (65) 6777 8211
F (65) 6777 0947 / (65) 6777 0743
Enquiries@AP.EmersonProcess.com



ROSEMOUNT

www.rosemount.com



EMERSON
Process Management